

JAW PULLERS

Mechanical 2 & 3 Jaw Pullers

Choosing the right size puller: Compare the “reach” and “spread” of the pulling job with that of the pullers listed. The puller selected must have dimensions greater than those of the job.

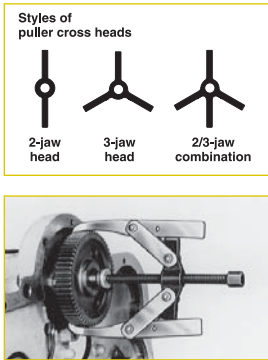

Shaft protector





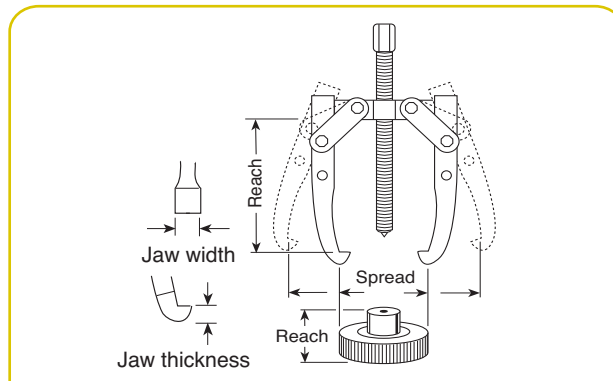

Pulling attachment

- Lock-Jaw™ feature on all pullers. The harder the pull, the tighter the grip for removing gears, bearings and countless other press fitted parts.
- 2-way, 3-way and 2/3 way combination pullers make it easy to select a specific puller for a specific application.
- Forged from high quality steel, heat treated and subjected to rigorous tests which exceed rated puller capacity.
- Meets Fed. Spec.: GGG-P-00781-D



Step plate





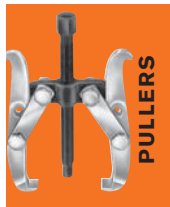





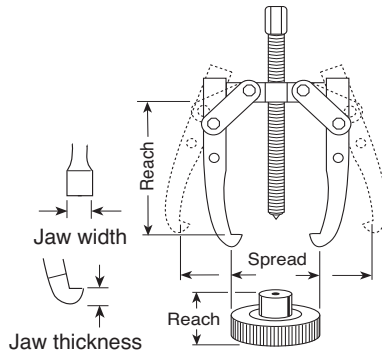



Order No.	Max.		Screw Size (in.)	Jaw		Capacity, Style and Weight
	Reach (in.)	Spread (in.)		Thickness (in.)	Width (in.)	
 	2 1/8	3 1/4	5/16-24 x 3 7/8	9/64	1/4	1-Ton, 2-Jaw; 5 oz.
	2 1/8	3 1/4				1-Ton, 3-Jaw; 8 oz.
 	3 3/8	4	3/8-24 x 4 7/8	Upper 3/16	Upper 1/4	2-ton, 2-Jaw; 14 oz. (Reversible Jaws)
	3 3/8	4 3/4		3/8-24 x 4 7/8	Lower 1/8	Lower 1/2
 	3 1/4	6	9/16-20 x 6 15/16	Upper 5/16	Upper 3/8	5-Ton, 2-Jaw; 1 lb., 12 oz. (Reversible Jaws)
	3 1/4	7		9/16-20 x 6 15/16	Lower 1/4	Lower 3/4



PULLERS

- Alloy steel heads are forged for maximum strength.
- Forcing screw threads are rolled, not cut. This process creates a smoother and stronger thread.
- Heat treated alloy steel cross bolts for maximum shear strength.
- Machined puller jaw toes produce larger and stronger pulling toes.



Order No.	Max.		Screw Size (in.)	Jaw		Capacity, Style and Weight	
	Reach (in.)	Spread (in.)		Thickness (in.)	Width (in.)		
1025  1027 	1025	5 1/2	6	9/16-20 x 6 15/16	Upper 5/16 Lower 1/4	Upper 3/8 Lower 3/4	5-Ton, Long 2-Jaw; 2 lbs. (Reversible Jaws)
	1027	5 1/2	7	9/16-20 x 6 15/16	Upper 5/16 Lower 1/4	Upper 3/8 Lower 3/4	5-Ton, Long 2/3-Jaw; 3 lbs., 10 oz. (Rev. Jaws)
1035  1037 	1035	5	9	11/16-18 x 9	Upper 5/16 Lower 11/32	Upper 1 Lower 1	7-Ton, 2-Jaw; 4 lbs., 8 oz. (Reversible Jaws)
	1037	5	10 1/2	11/16-18 x 9	Upper 5/16 Lower 11/32	Upper 1 Lower 1	7-Ton, 2/3-Jaw; 6 lbs., 2 oz. (Rev. Jaws)
1036  1038 	1036	8 3/4	9 1/2	11/16-18 x 9	11/32	1	7-Ton, Long 2-Jaw; 5 lbs., 6 oz.
	1038	8 3/4	11	11/16-18 x 9	11/32	1	7-Ton, Long 2/3-Jaw; 8 lbs., 2 oz.
1039/1040  1041/1042 	1039	11	12	13/16-16 x 12	9/16	1	13-Ton, 2-Jaw; 10 lbs., 13 oz.
	1040	15 1/4	15 1/2	13/16-16 x 12	9/16	1	13-Ton, Long 2-Jaw; 13 lbs.
	1041	11	12	13/16-16 x 12	9/16	1	13-Ton, 2/3-Jaw; 16 lbs., 4 oz.
	1042	15 1/4	17	13/16-16 x 12	9/16	1	13-Ton, Long 2/3-Jaw; 18 lbs., 12 oz.
1043/1044  1045/1046 	1043	14 1/2	14	1-14 x 13 1/2"	9/16	1	17 1/2-Ton, Long 2-Jaw; 23 lbs.
	1044	18 3/4	16	1-14 x 13 1/2" lg.	13/16	1 9/32	17 1/2-Ton, Long 2-Jaw; 26 lbs.
	1045	14 1/2	14	1-14 x 13 1/2	13/16	1 9/32	17 1/2-Ton, 3-Jaw; 33 lbs.
	1046	18 3/4	16	1-14 x 13 1/2	13/16	1 9/32	17 1/2-Ton, Long 3-Jaw; 37 lbs.
1048  1050 	1048	22 1/4	20	1 1/4-12 x 16 5/8	1 1/16	1 1/2	25-Ton, Long 2-Jaw; 42 lbs., 12 oz.
	1050	22 1/4	20	1 1/4-12 x 16 5/8	1 1/16	1 1/2	25-Ton, Long 3-Jaw; 60 lbs.



For puller piece part identification, order Power Team parts catalog PC97